



# INDEX

	PAGES
<b>1. INTRODUCTION</b>	<b>2</b>
<b>2. PACKING LIST</b>	<b>3</b>
<b>3. PRODUCT SPECIFICATIONS</b>	<b>4</b>
<b>4. BOARD LAYOUT</b>	<b>5</b>
<b>5. HARDWARE INSTALLATION</b>	<b>6</b>
<b>6. GETTING STARTED</b>	<b>8</b>
<b>7. HIGHLIGHTED FEATURES</b>	<b>20</b>
<b>8. PYTHON DEMO CODE</b>	<b>21</b>
<b>9. SCHEMATIC</b>	<b>24</b>
<b>10. GALLERY</b>	<b>25</b>
<b>11. WARRANTY</b>	<b>27</b>

## 1. INTRODUCTION

What is [HAT](#)? [HAT](#) means **H**ardware **A**ttached on **T**op. If [Arduino](#) have [Shield](#), [Raspberry Pi](#) (refer to Raspberry Pi B+/2/3/3B+) uses [HAT](#). But with the smaller board, Raspberry Pi [Zero/W/WH](#) is introduced, pHAT (**p**artially **H**ardware **A**ttached on **T**op) emerged too. [Shield](#) and [HAT/pHAT](#) have the same objective - to ease the hardware development.

Raspberry Pi aims to bring the power of computing and digital making to the masses. It is being used by many educators, makers, and also engineers. I am sure you will have similar constraints when get started from scratch, example:

- Lack of on board USB to UART communication for your computer to get the ip address for SSH (headless), or to kick start configuration directly.
- There is no GPIO status indicator when you write program to control particular pin.
- Access to GPIO is kind of difficult because there is no label, you need to search online to get the designated pin.
- And there is no extra programmable push button for proper shutdown (hardware) :(

We would like to introduce Maker pHAT. It is designed to ease everyone in getting started with Raspberry Pi in the absence of additional monitor, keyboard or mouse (Headless); and also prototyping. It helps user to remote access Raspberry Pi through serial with minimum steps. The on board LEDs, push buttons and buzzer will further assist beginner in interfacing with sensors, actuator and coding.

*“Maker pHAT is designed for anyone who want to get start with any Raspberry Pi projects”*



Maker pHAT comes with the following features:

- Raspberry Pi Zero Size, stack perfectly on to Pi Zero Series of SBC (Single Board Computer).
- Compatible with standard [Raspberry Pi 3B/3B+](#) and small size [Raspberry Pi Zero/W/WH](#).
- Standard Raspberry Pi GPIO footprint.
- LED array for selected GPIO pins (GPIO 17, 18, 27, 22, 25, 12, 13, 19).
- 3x on board programmable push buttons (GPIO 21, 19 and 20, need to configure as input pull up).
- On board active buzzer (GPIO 26).
- Proper label for all GPIOs, including SPI, UART, I2C, 5V, 3.3V, and GND.
- Utilize USB Micro-B socket for 5V input and USB to UART communication.
- USB serial facilitated by the CH340.
- Input voltage: USB 5V, from computer, power bank or standard USB adapter.
- **PURPLE PCB!**

## 2. PACKING LIST

Please check the parts and components according to the packing list. If there are any parts missing, please contact us at [sales@cytron.io](mailto:sales@cytron.io) immediately.

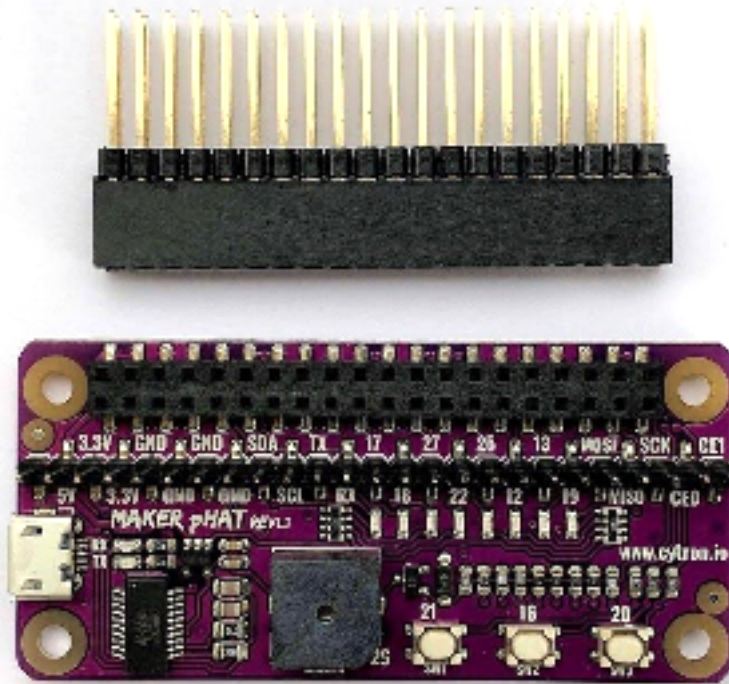

No	ITEMS	QUANTITY
1	Maker pHAT (Code: HAT-MAKER)	1
2	2x20 Stacking Header (Code: CN-PH-PC104)	1

### 3. PRODUCT SPECIFICATIONS

Dimension:

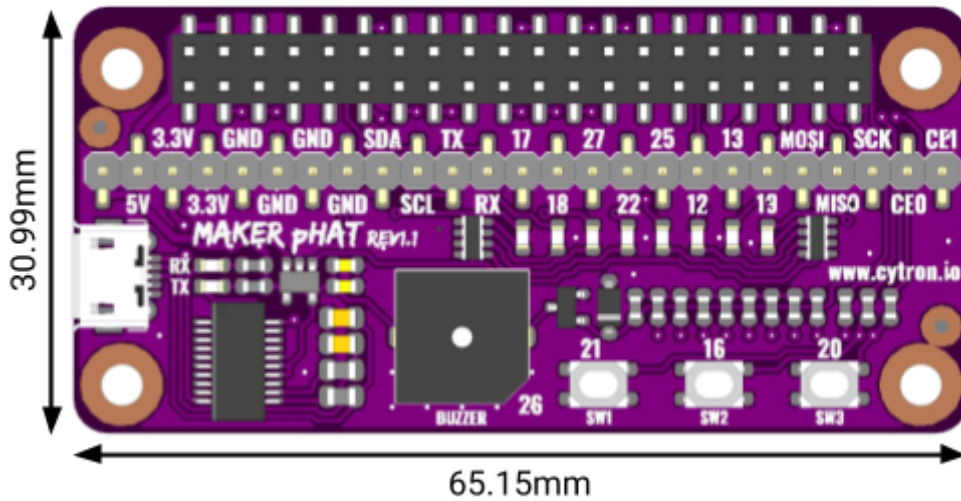

Absolute Maximum Rating of Maker pHAT:

No	PARAMETERS	Min	Typ	Max	Unit
1	Input Voltage via USB connector	4.8	-	5.2	V
2	DC Current for 5V Pin (Max Continuous)	-	-	USB	mA

## 4. BOARD LAYOUT

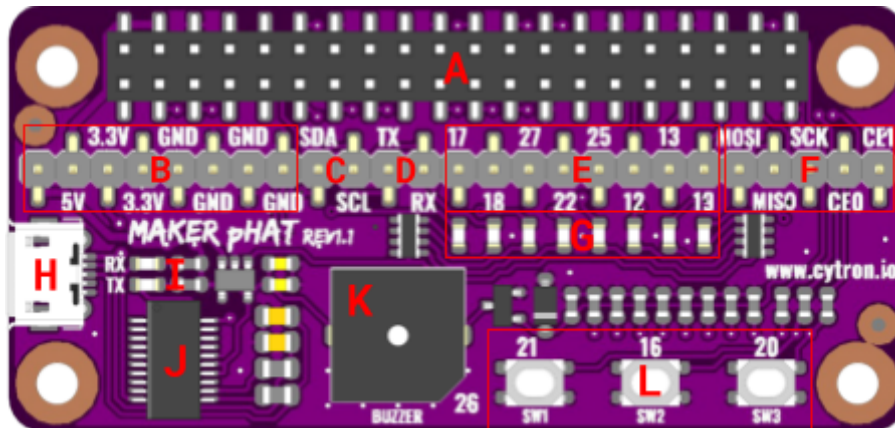

LABEL	FUNCTION
<b>A</b>	<b>RASPBERRY PI STANDARD 40 HEADER PIN</b> Stack this pHAT to Raspberry Pi through this standard 40 header pin.
<b>B</b>	<b>BREAKOUT POWER PIN</b> User can access 5V, 3.3V and GND through power pins.
<b>C</b>	<b>BREAKOUT I<sup>2</sup>C PIN</b> User can access SDA (GPIO 2) and SCL (GPIO 3) through I2C pins.
<b>D</b>	<b>BREAKOUT UART PIN</b> User can access TX (GPIO 14) and RX (GPIO 15) through UART pins.
<b>E</b>	<b>BREAKOUT GPIO PIN</b> User can access GPIO 17, 18, 27, 22, 25, 12, 13, 19 through GPIO pins.
<b>F</b>	<b>BREAKOUT SPI PIN</b> User can access MOSI (GPIO 10), MISO (GPIO 9), SCK (GPIO 11), CE0 (GPIO 8) and CE1 (GPIO 7) through SPI pins.
<b>G</b>	<b>GPIO INDICATOR LED</b> Selected GPIO is equipped with LED, where it can controlled or act as indicator for input.
<b>H</b>	<b>USB MICRO B CONNECTOR</b> Supply (alternative) to Raspberry Pi and to remote through SSH serial.
<b>I</b>	<b>USB-SERIAL INDICATOR LED</b> Indicates USB-Serial activity.
<b>J</b>	<b>USB-SERIAL IC CONVERTER (FT231X)</b> Converts USB data to serial data. Used to remote Raspberry Pi using SSH serial.
<b>K</b>	<b>ACTIVE BUZZER</b> Active buzzer is connected to GPIO 26. Signal HIGH will activate the buzzer and signal LOW will turn off the buzzer.
<b>L</b>	<b>PROGRAMMABLE PUSH BUTTONS</b> 3 programmable push button is connected to GPIO 21, 16 and 20. To use it, user need to configure it as input pull up.



## 5. HARDWARE INSTALLATION

### 5.1 Raspberry Pi Zero WH

Maker pHAT is designed to fit in [Raspberry Pi Zero](#) footprint, means it can fit on [Raspberry Pi Zero W](#) and [Raspberry Pi Zero WH](#). It can stack to [Raspberry Pi Zero WH](#) directly without any extra components.

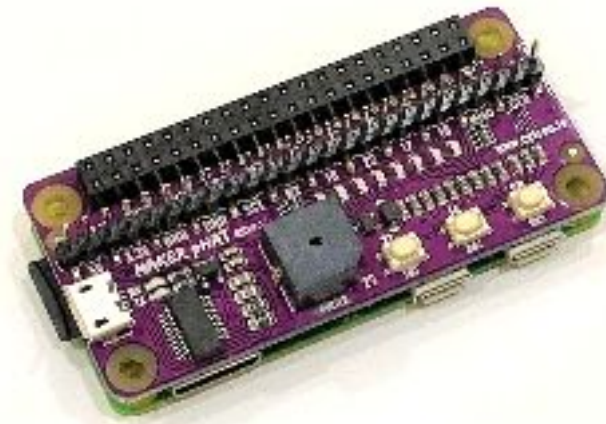

### 5.2 Raspberry Pi 3 Model B and Model B Plus

Maker pHAT has standard [Raspberry Pi](#) GPIO footprint. So, it is compatible with [Raspberry Pi 3 Model B](#) or [Model B Plus](#) too. You need [PC104 Header Pin \(2x20\)](#) in order to stack Maker pHAT on [Raspberry Pi](#).



### 5.3 Access Breakout Pads on Maker pHAT

Maker pHAT Rev1.10 comes with pre-soldered SMD header pin on the breakout pads.

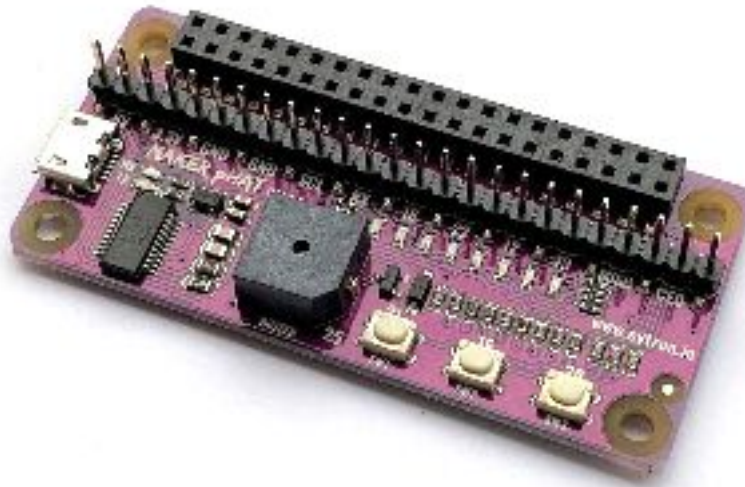

No worry about short circuit when you stack the Maker pHAT Rev1.10 on the [Raspberry Pi Zero WH](#).

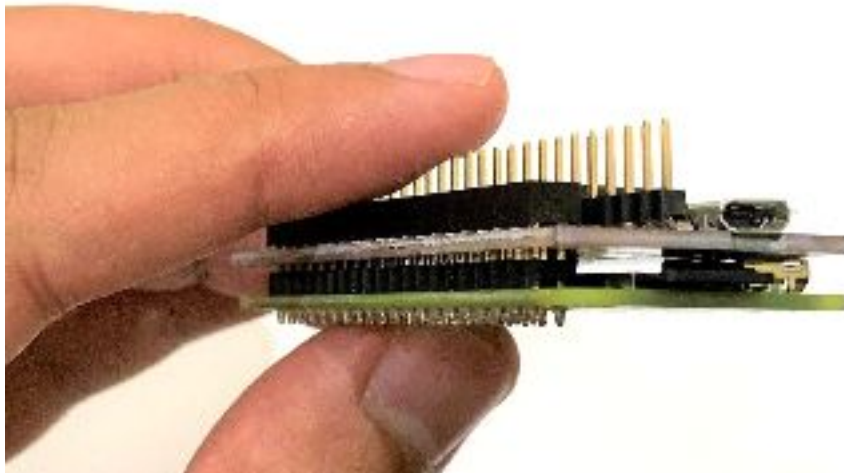



## 6. GETTING STARTED

### 6.1 Preparing Hardware

To get started, we recommend you to have:

1. [Maker pHAT](#)
2. [Raspberry Pi Zero WH](#)
3. [16GB Micro SD Card](#)
4. [USB Micro B Cable](#)

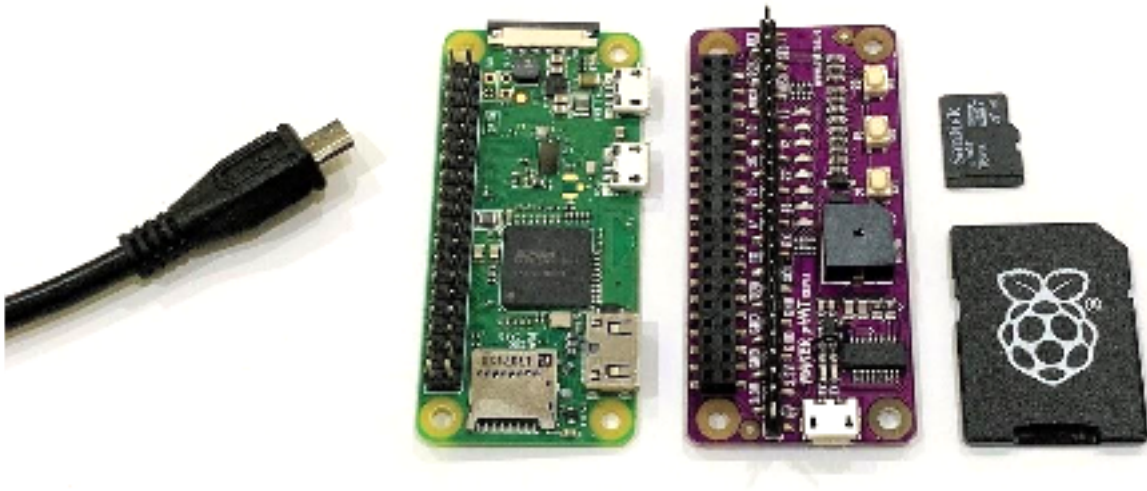

### 6.2 Install the latest Raspbian OS

**Note:** The latest NOOBS (V2.9.0) already comes with Raspbian pre-installed. If you get [16GB Micro SD Card with NOOBS for RPI](#), you don't need to write Raspbian image.

Download the latest Raspbian OS ([Raspbian Stretch with Desktop](#)) and write the image on the [SD card](#) using [Etcher](#).

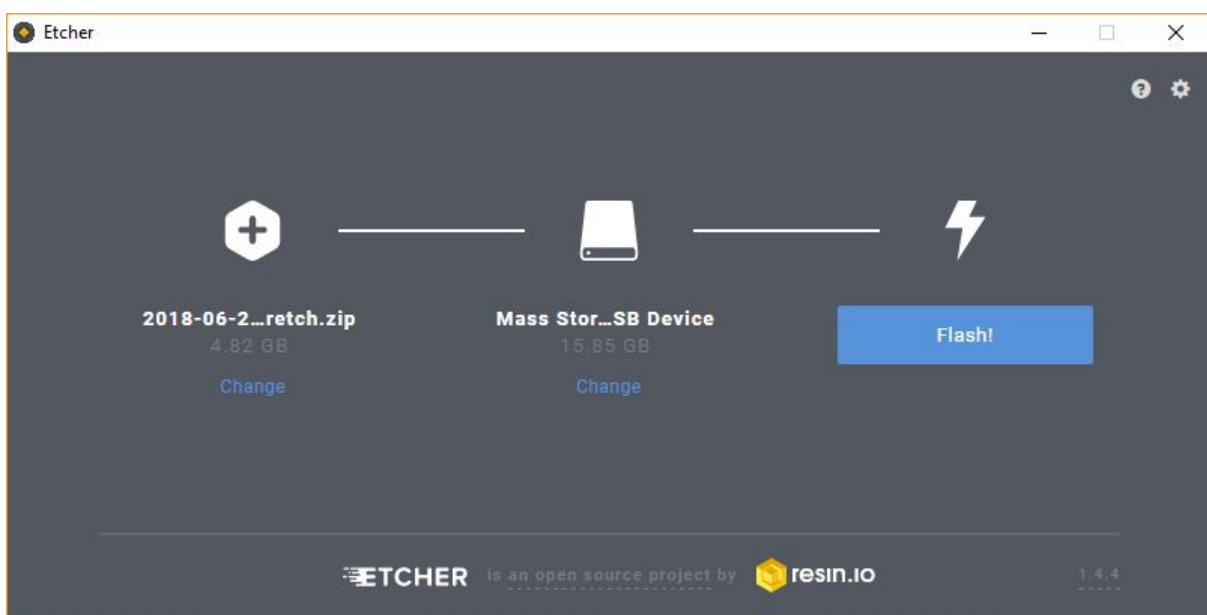

After done flashing, take the [SD card](#) out and insert back to your laptop. Open [SD card](#) directory (e.g. D:/boot) and open **config.txt** file. Put **enable\_uart=1** at the bottom of the line. Save and eject the [SD card](#). Then insert the [SD card](#) into [Raspberry Pi Zero WH](#).

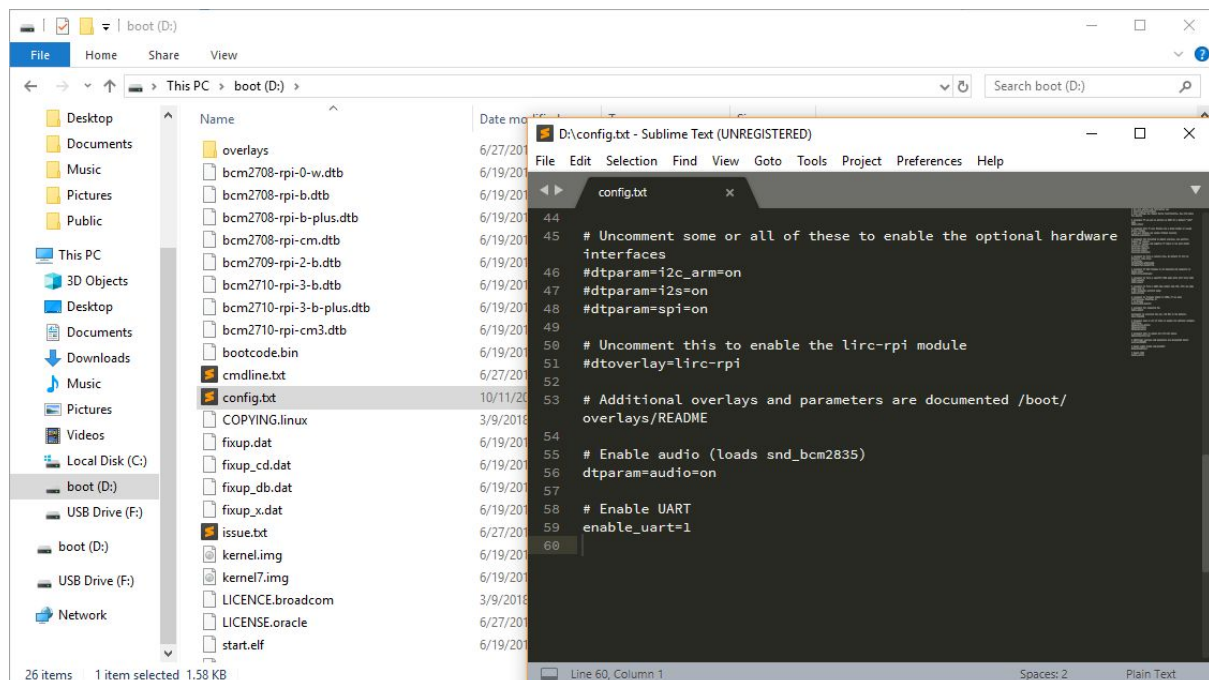

### 6.3 Install Maker pHAT Driver

Don't stack the Maker pHAT to [Raspberry Pi Zero WH](#) yet. Connect Maker pHAT to your laptop using [USB Micro B Cable](#). Check either your laptop is able to detect the Maker pHAT. Open Device Manager, and check under **Ports (COM & LPT)** category. It should be detected as **USB Serial Port (COM number)**. If yes, you can proceed to the next step. If not, download and install Maker pHAT driver.

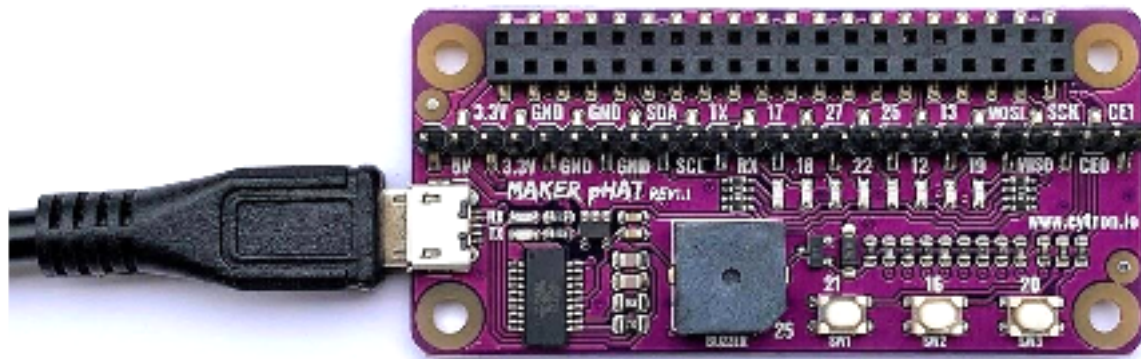

Download and install Maker pHAT driver. Please choose appropriate driver depends on your laptop/PC operating system:

- [Windows 10](#)
- [MacOS](#)

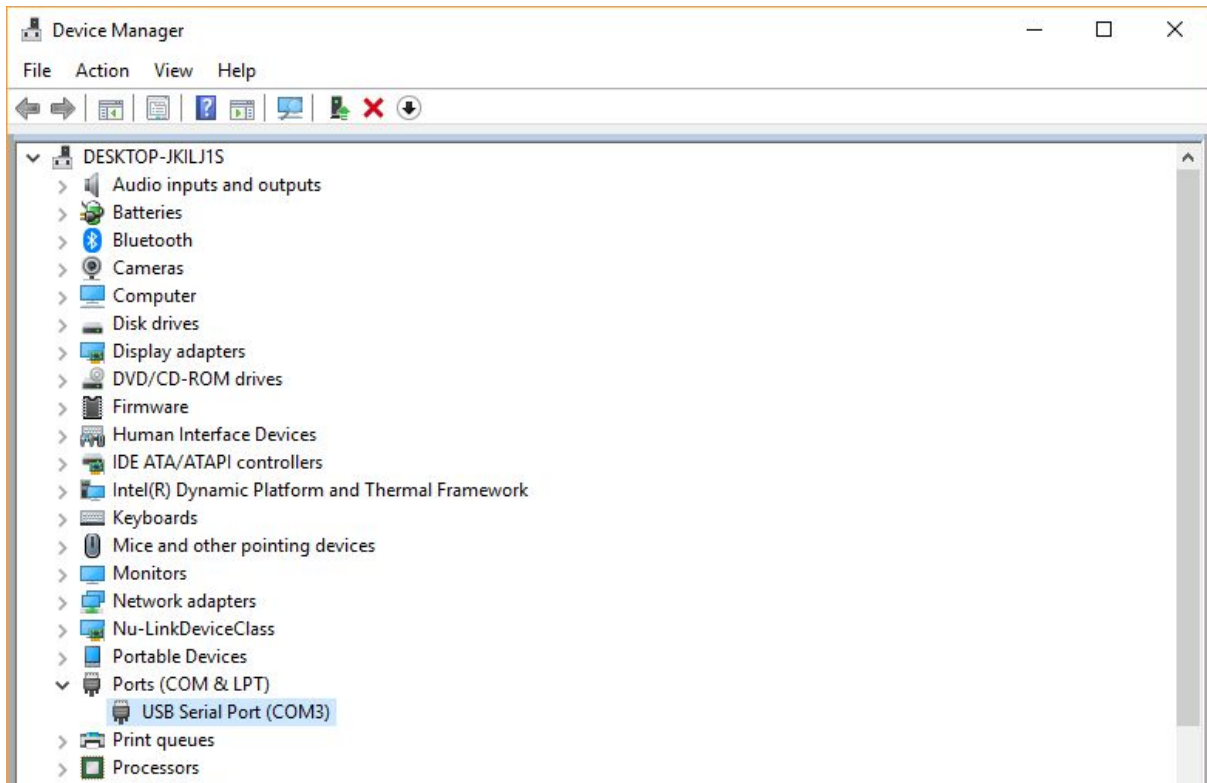

Once detected, disconnect the [USB cable](#). Stack Maker pHAT on the top of [Raspberry Pi Zero WH](#).

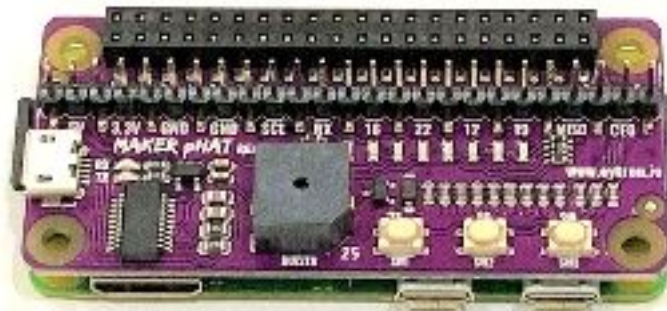

## 6.4 Install PuTTY (Windows)

For Windows user, download and install [PuTTY](#). Connect your Maker pHAT to your laptop using [USB Micro B Cable](#). Since Maker pHAT is already stacked on the Raspberry Pi, this connection will power up Raspberry Pi through Maker pHAT. **Please be reminded to not simply disconnect the cable without proper shutdown, it might corrupt the microSD card.**





Open [PuTTY](#) software. Tick on the **Serial**, then write your **COM number** (e.g. COM3). Please refer to your Device Manager. Set Speed to **115200**. Then click **Open**.

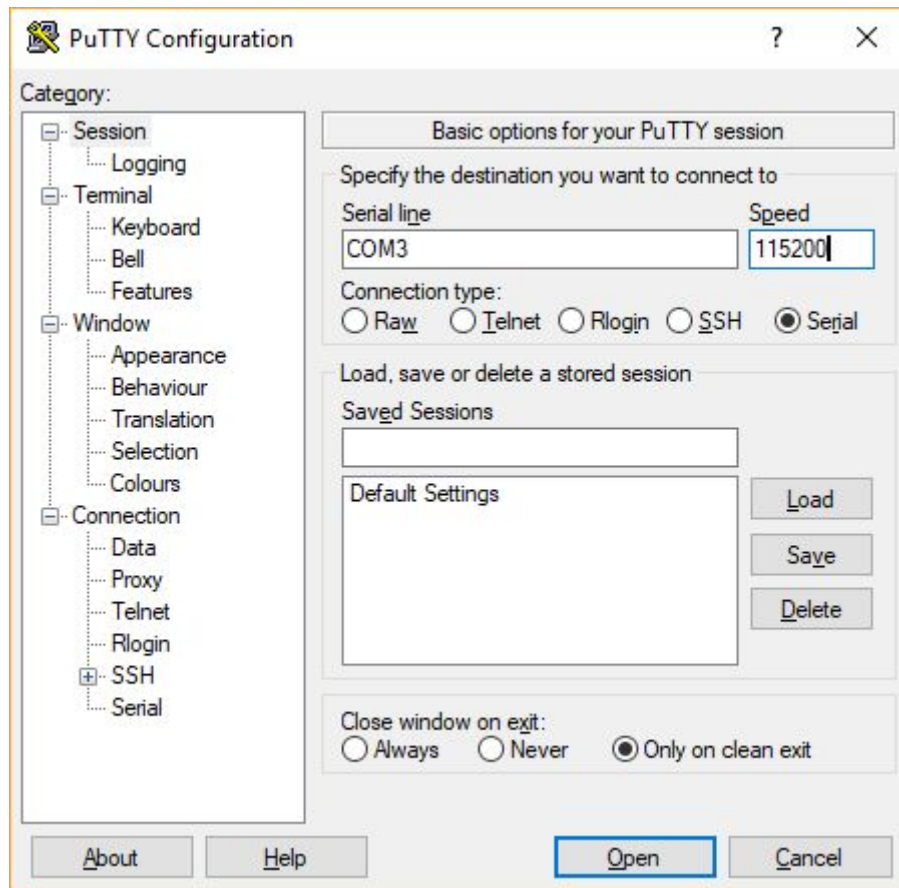

Press Enter, then insert Raspberry Pi default login information as follow.

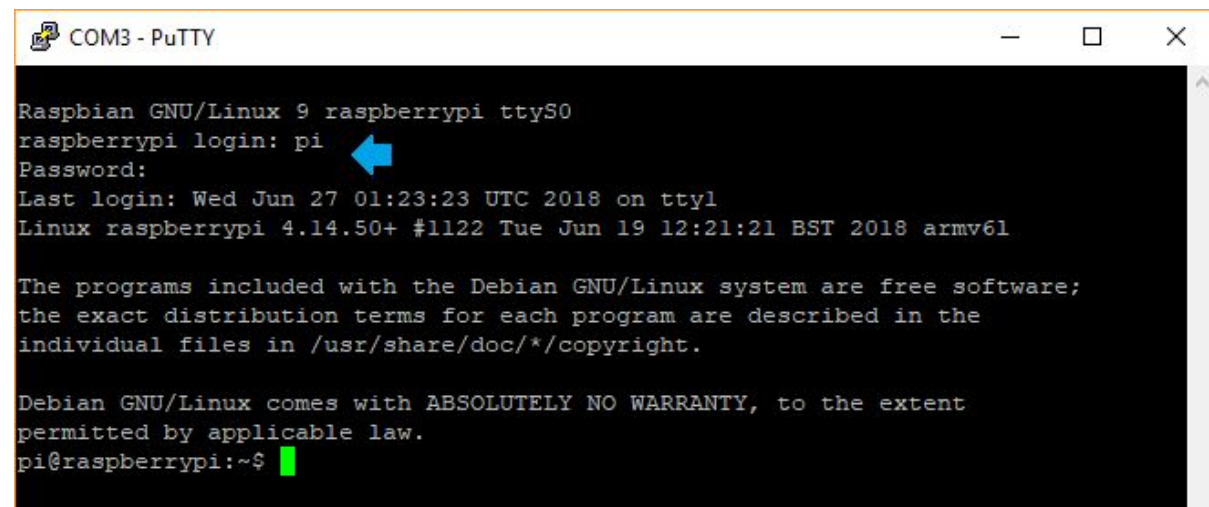
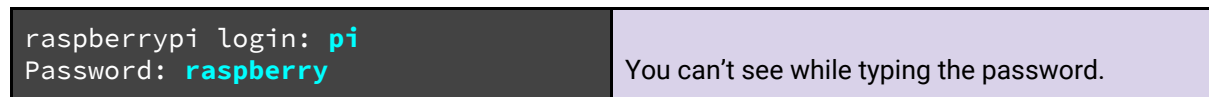

So far, you're able to access Raspberry Pi through serial remote (Maker pHAT). We will further guide you until we can remote using [VNC Viewer](#) (Virtual Network Computing).

## 6.5 Connect to WiFi

To remote using [VNC Viewer](#), we need a WiFi connection. We can set the WiFi connection in Raspberry Pi Software Configuration Tool. Write the following command and Enter.

```
pi@raspberrypi:~$ sudo raspi-config
```

 To enter Raspberry Pi Configuration Tool.

```
Debian GNU/Linux comes with ABSOLUTELY NO WARRANTY, to the extent  
permitted by applicable law.  
pi@raspberrypi:~$ sudo raspi-config
```

Go to number **2 Network Options**. Then Enter.

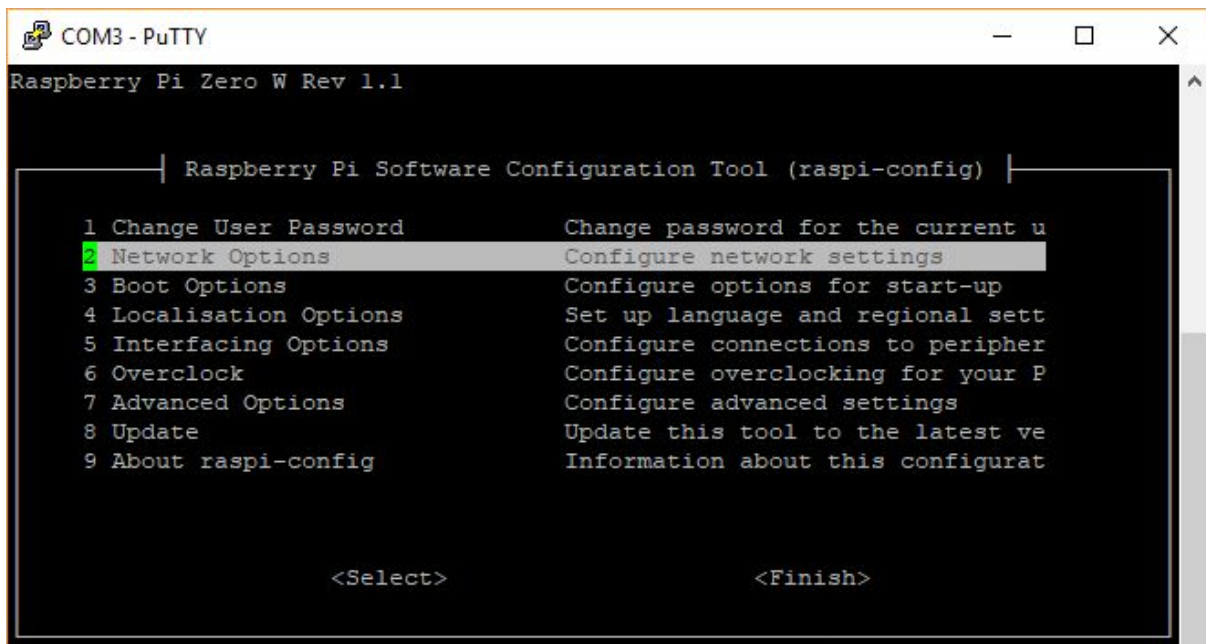

```
COM3 - PuTTY  
Raspberry Pi Zero W Rev 1.1  
Raspberry Pi Software Configuration Tool (raspi-config)  
1 Change User Password      Change password for the current u  
2 Network Options           Configure network settings  
3 Boot Options              Configure options for start-up  
4 Localisation Options     Set up language and regional sett  
5 Interfacing Options      Configure connections to peripher  
6 Overclock                 Configure overclocking for your P  
7 Advanced Options         Configure advanced settings  
8 Update                    Update this tool to the latest ve  
9 About raspi-config        Information about this configurat  
  
<Select>                   <Finish>
```

Choose **N2 Wi-fi** and Enter.

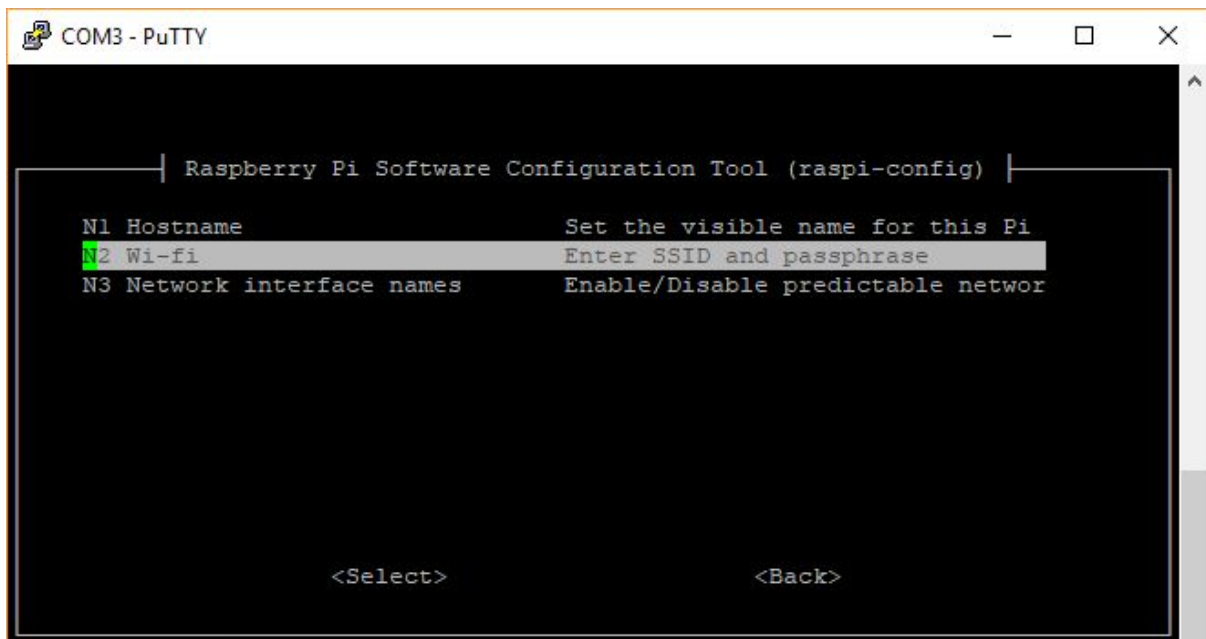

```
COM3 - PuTTY  
Raspberry Pi Software Configuration Tool (raspi-config)  
N1 Hostname                  Set the visible name for this Pi  
N2 Wi-fi                     Enter SSID and passphrase  
N3 Network interface names  Enable/Disable predictable networ  
  
<Select>                   <Back>
```



Choose your country and press Enter.

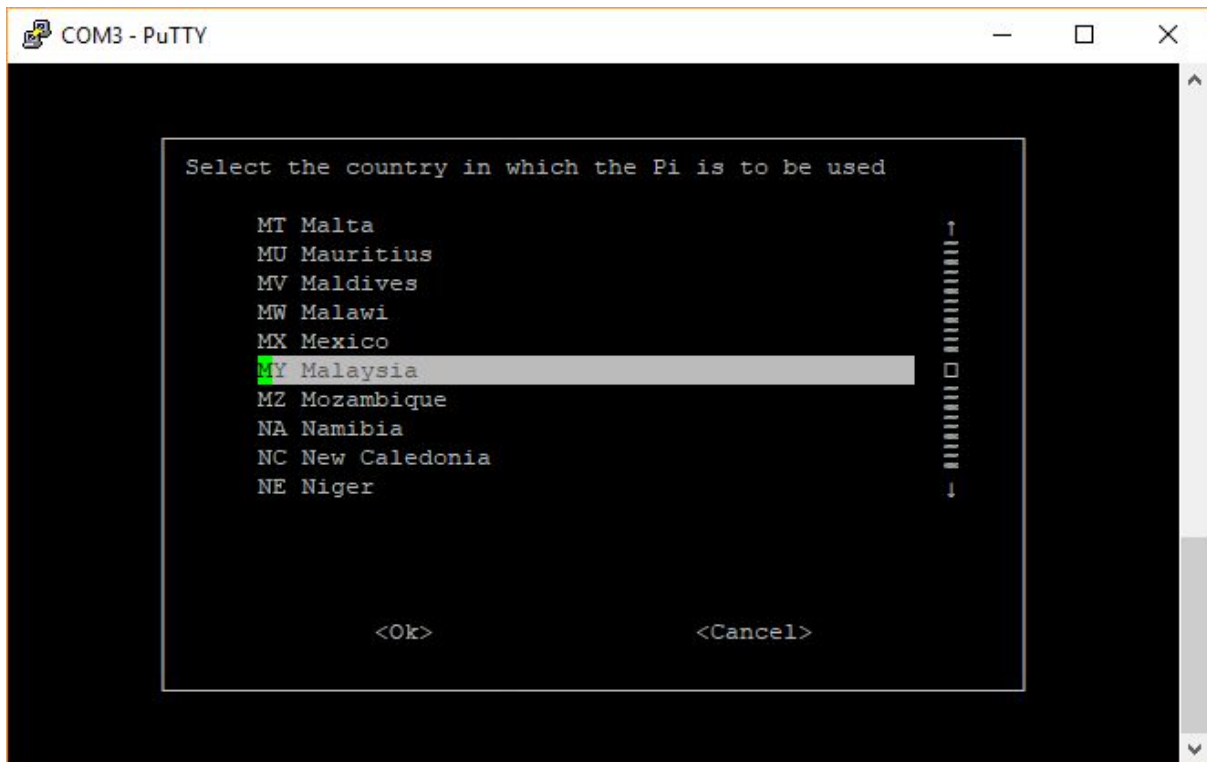

Confirm your WiFi country by pressing Enter.

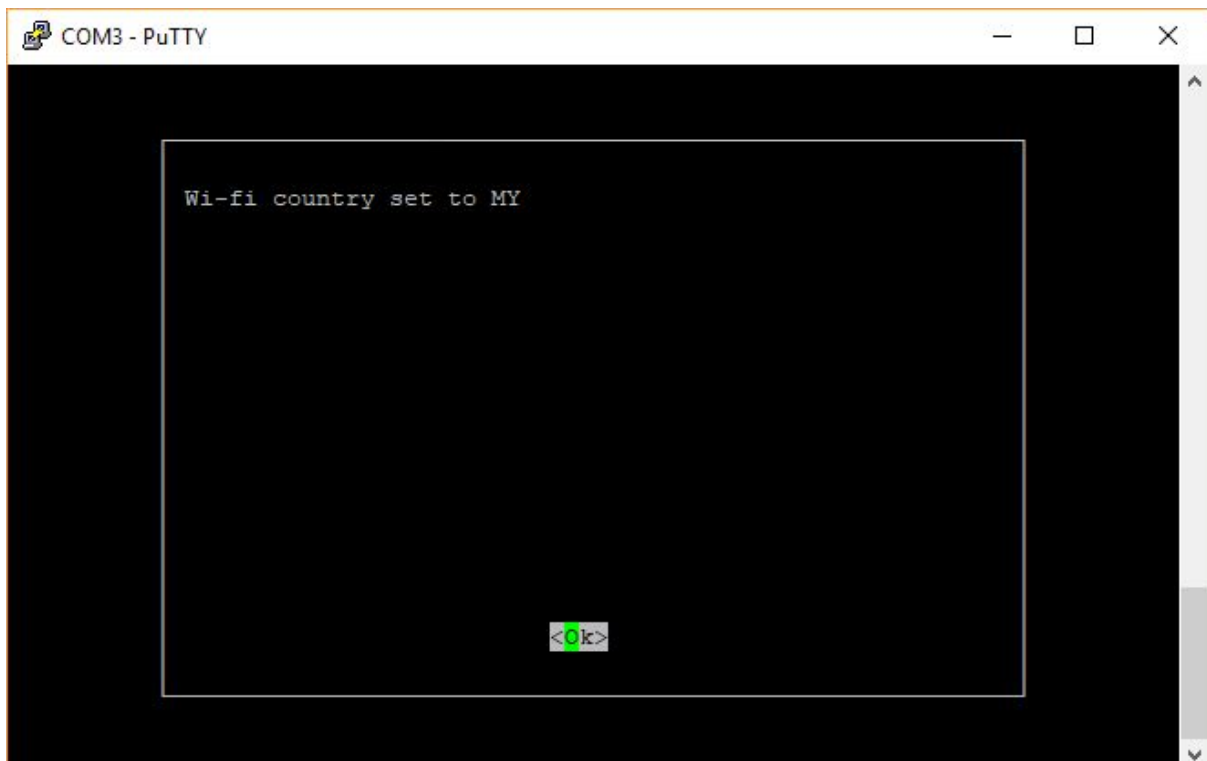

Write your WiFi SSID (WiFi name) then Enter, followed by WiFi passphrase (WiFi password) then Enter.

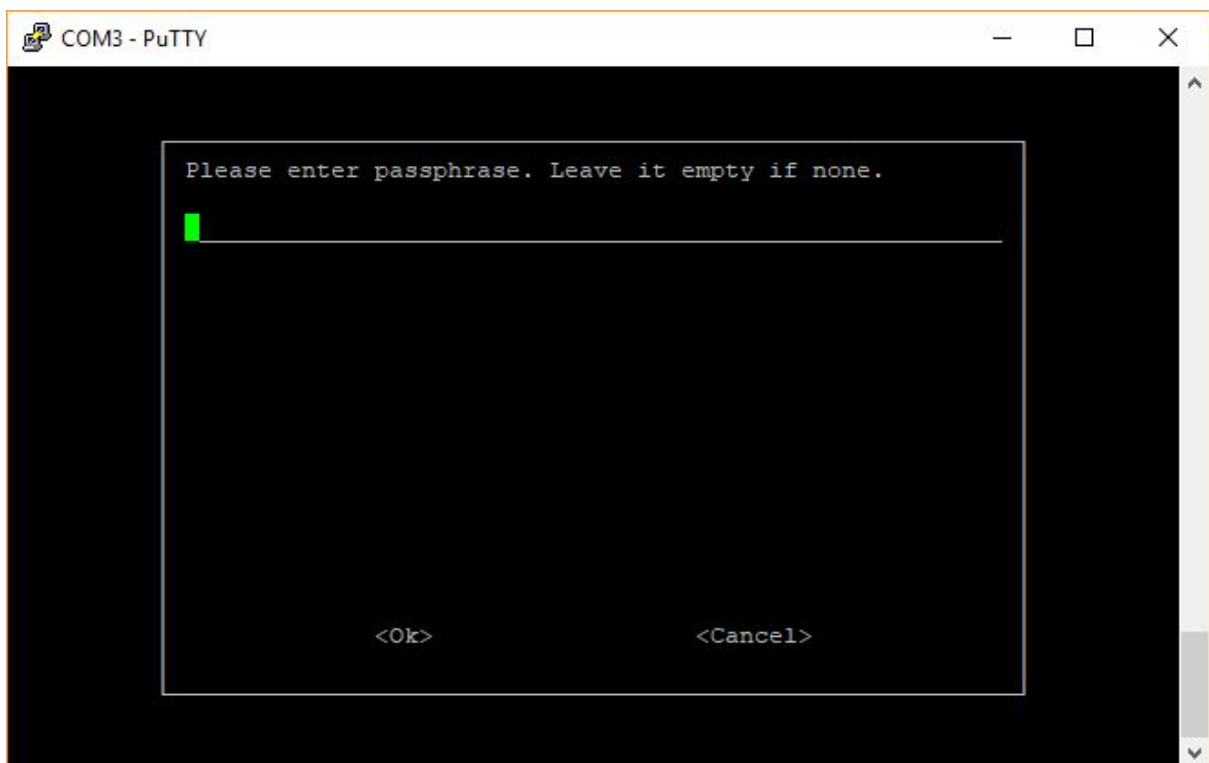
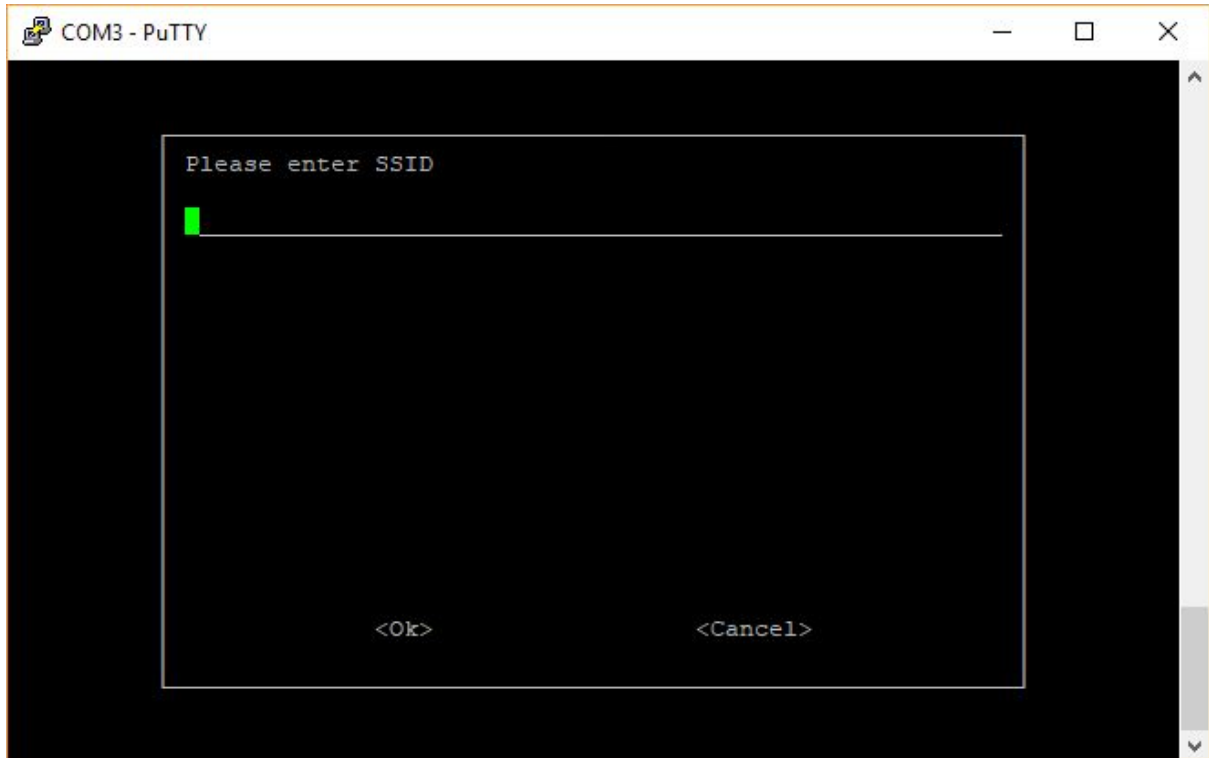

Done setting for WiFi connection. Press Enter to **<Ok>**.

Next, we need to enable VNC server in Raspberry Pi. Go back to the top menu, and select to the number **5 Interfacing Options**.

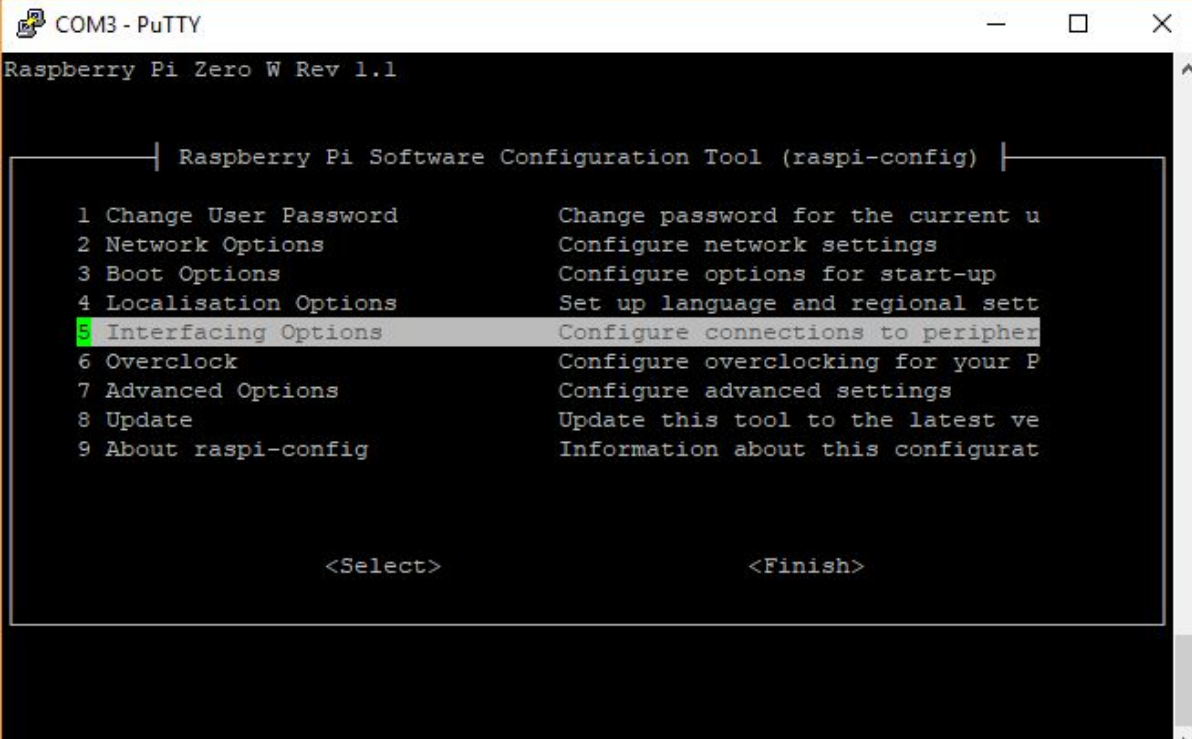

```
COM3 - PuTTY
Raspberry Pi Zero W Rev 1.1

Raspberry Pi Software Configuration Tool (raspi-config)

1 Change User Password      Change password for the current u
2 Network Options           Configure network settings
3 Boot Options              Configure options for start-up
4 Localisation Options      Set up language and regional sett
5 Interfacing Options       Configure connections to peripher
6 Overclock                 Configure overclocking for your P
7 Advanced Options         Configure advanced settings
8 Update                   Update this tool to the latest ve
9 About raspi-config        Information about this configurat

<Select>                    <Finish>
```

Select **P3 VNC** and Enter.

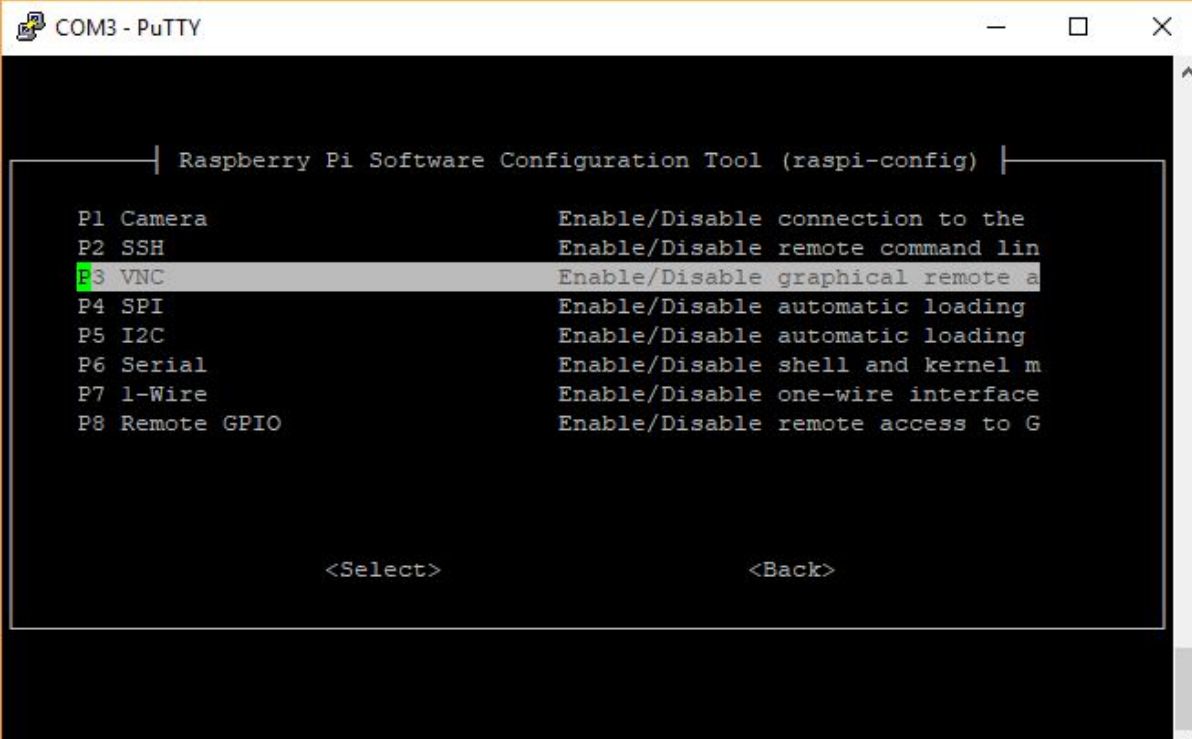

```
COM3 - PuTTY

Raspberry Pi Software Configuration Tool (raspi-config)

P1 Camera                  Enable/Disable connection to the
P2 SSH                     Enable/Disable remote command lin
P3 VNC                     Enable/Disable graphical remote a
P4 SPI                     Enable/Disable automatic loading
P5 I2C                     Enable/Disable automatic loading
P6 Serial                  Enable/Disable shell and kernel m
P7 1-Wire                  Enable/Disable one-wire interface
P8 Remote GPIO             Enable/Disable remote access to G

<Select>                    <Back>
```

Choose **<Yes>** and Enter.

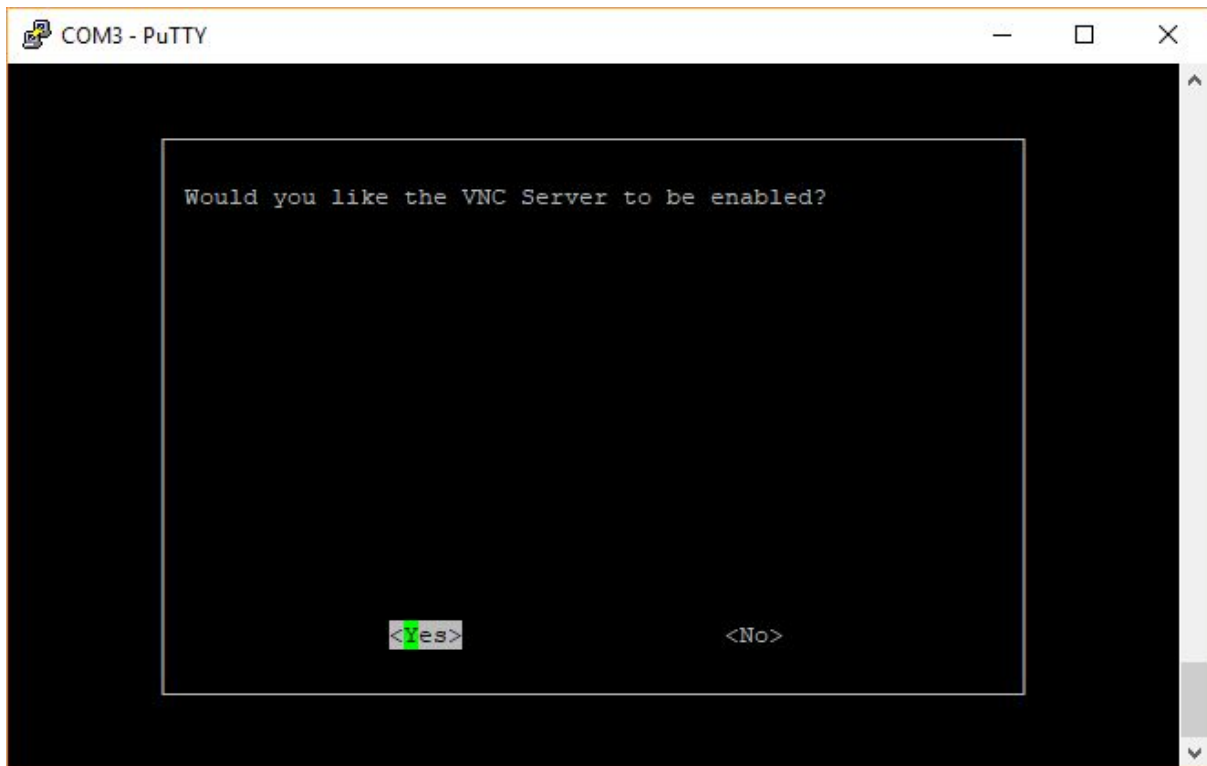

VNC server is enabled. Press Enter to **<Ok>**.

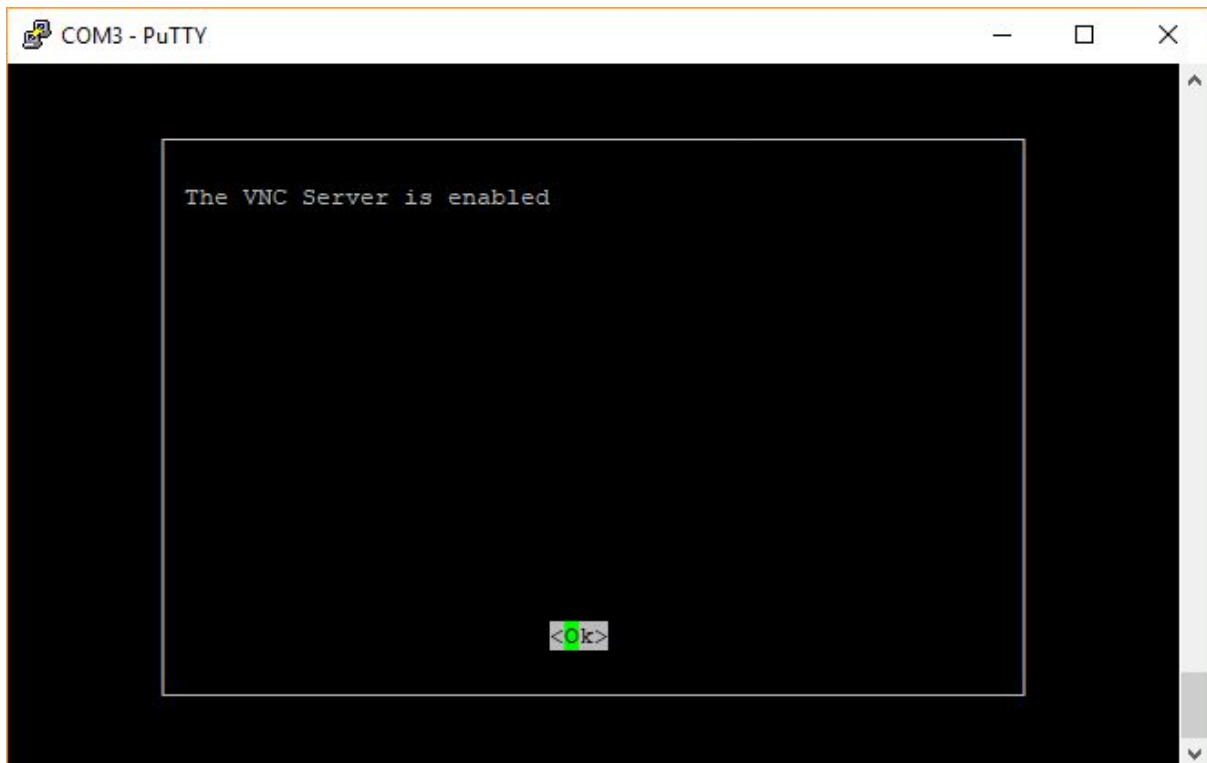

Press **Esc** to exit Raspberry Pi Configuration Tool. Now, reboot Raspberry Pi to enable WiFi connection and VNC server. Write following command followed by Enter.

```
pi@raspberrypi:~$ sudo reboot
```

Restart Raspberry Pi.

```
COM3 - PuTTY
Raspberry Pi Zero W Rev 1.1

Raspberry Pi Software Configuration Tool (raspi-config)

1 Change User Password      Change password for the current u
2 Network Options          Configure network settings
3 Boot Options              Configure options for start-up
4 Localisation Options     Set up language and regional sett
5 Interfacing Options      Configure connections to peripher
6 Overclock                Configure overclocking for your P
7 Advanced Options         Configure advanced settings
8 Update                   Update this tool to the latest ve
9 About raspi-config       Information about this configurat

<Select>                    <Finish>

pi@raspberrypi:~$ sudo reboot
```

Login to Raspberry Pi like previous. If all your setting is correct, your Pi will connect to WiFi. Next we need to trace the IP address. Write following command and Enter.

```
pi@raspberrypi:~$ ifconfig
```

Check Raspberry Pi IP address.

```
pi@raspberrypi:~$ sudo reboot
[ 5775.593077] reboot: Restarting system

Raspbian GNU/Linux 9 raspberrypi ttyS0
raspberrypi login: pi
Password:
Last login: Thu Oct 11 05:17:56 UTC 2018 on tty1
Linux raspberrypi 4.14.50+ #1122 Tue Jun 19 12:21:21 BST 2018 armv6l

The programs included with the Debian GNU/Linux system are free software;
the exact distribution terms for each program are described in the
individual files in /usr/share/doc/*/copyright.

Debian GNU/Linux comes with ABSOLUTELY NO WARRANTY, to the extent
permitted by applicable law.
pi@raspberrypi:~$ ifconfig
```

Your Raspberry Pi will display IP address (e.g. 192.168.0.106).



```
COM3 - PuTTY
individual files in /usr/share/doc/*/copyright.

Debian GNU/Linux comes with ABSOLUTELY NO WARRANTY, to the extent
permitted by applicable law.
pi@raspberrypi:~$ ifconfig
lo: flags=73<UP,LOOPBACK,RUNNING> mtu 65536
    inet 127.0.0.1 netmask 255.0.0.0
    inet6 ::1 prefixlen 128 scopeid 0x10<host>
    loop txqueuelen 1000 (Local Loopback)
    RX packets 9 bytes 524 (524.0 B)
    RX errors 0 dropped 0 overruns 0 frame 0
    TX packets 9 bytes 524 (524.0 B)
    TX errors 0 dropped 0 overruns 0 carrier 0 collisions 0

wlan0: flags=4163<UP,BROADCAST,RUNNING,MULTICAST> mtu 1500
    inet 192.168.0.106 netmask 255.255.255.0 broadcast 192.168.0.255
    inet6 fe80::883:5143:9217:51ec prefixlen 64 scopeid 0x20<link>
    ether b8:27:eb:17:0e:6e txqueuelen 1000 (Ethernet)
    RX packets 406 bytes 67925 (66.3 KiB)
    RX errors 0 dropped 0 overruns 0 frame 0
    TX packets 56 bytes 8006 (7.8 KiB)
    TX errors 0 dropped 0 overruns 0 carrier 0 collisions 0

pi@raspberrypi:~$
```

We recommend you to update your Raspbian with following command.

```
pi@raspberrypi:~$ sudo apt-get update Update Raspbian OS.
```

Done update, open [VNC Viewer](#) and insert Raspberry Pi's IP address on the text bar. Then press Enter.

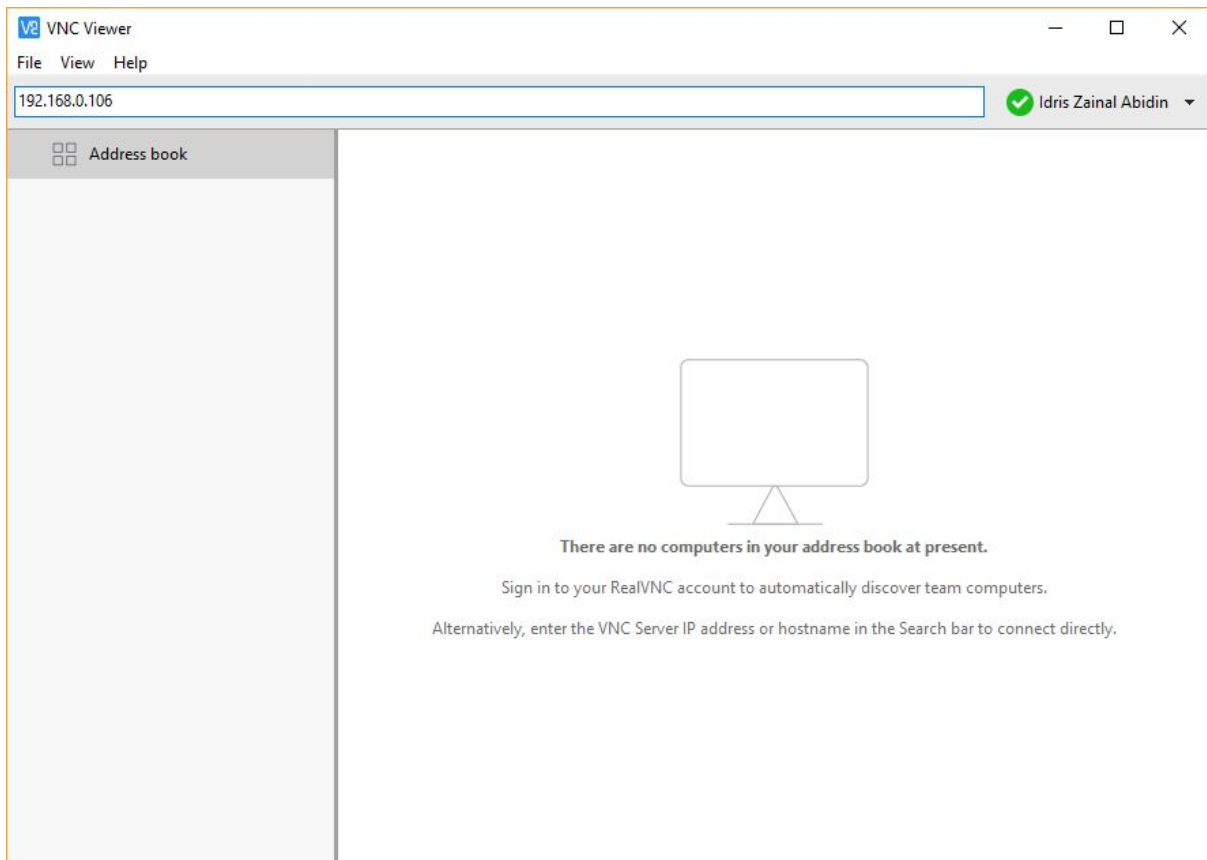

A warning window will popup. Sometimes the warning is in yellow and sometimes in red. Proceed with **Continue** button.

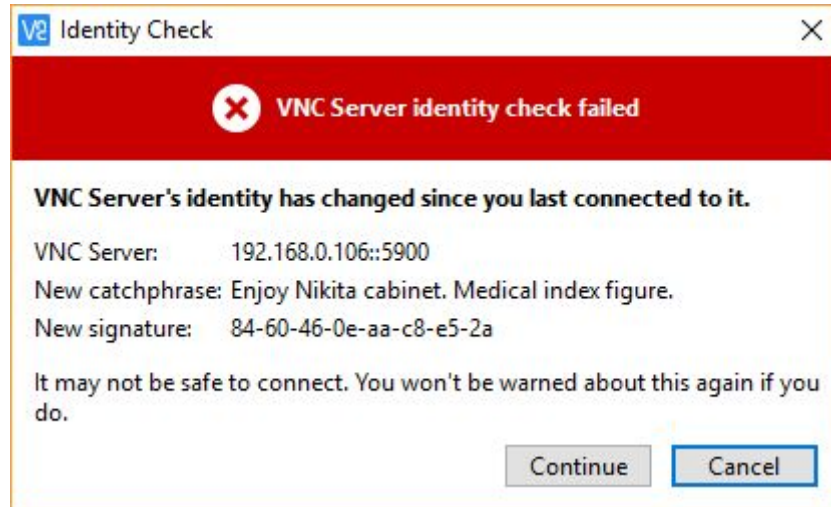

Fill up Raspberry Pi default login information.

Username: **pi**

Password: **raspberrypi**

Press **OK**.

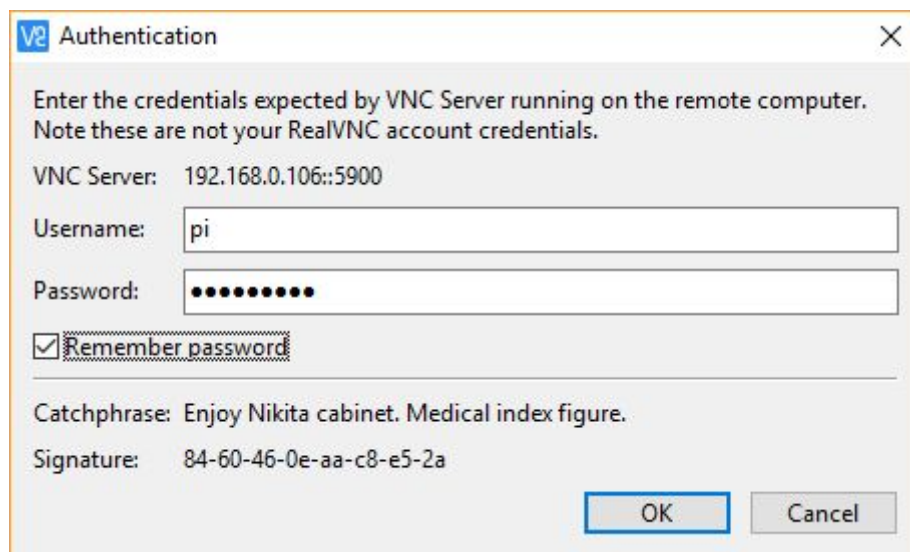

Tadaa. Your VNC remote is successful. Now you can access Raspberry Pi Desktop through [VNC Viewer](#) and WiFi connection.

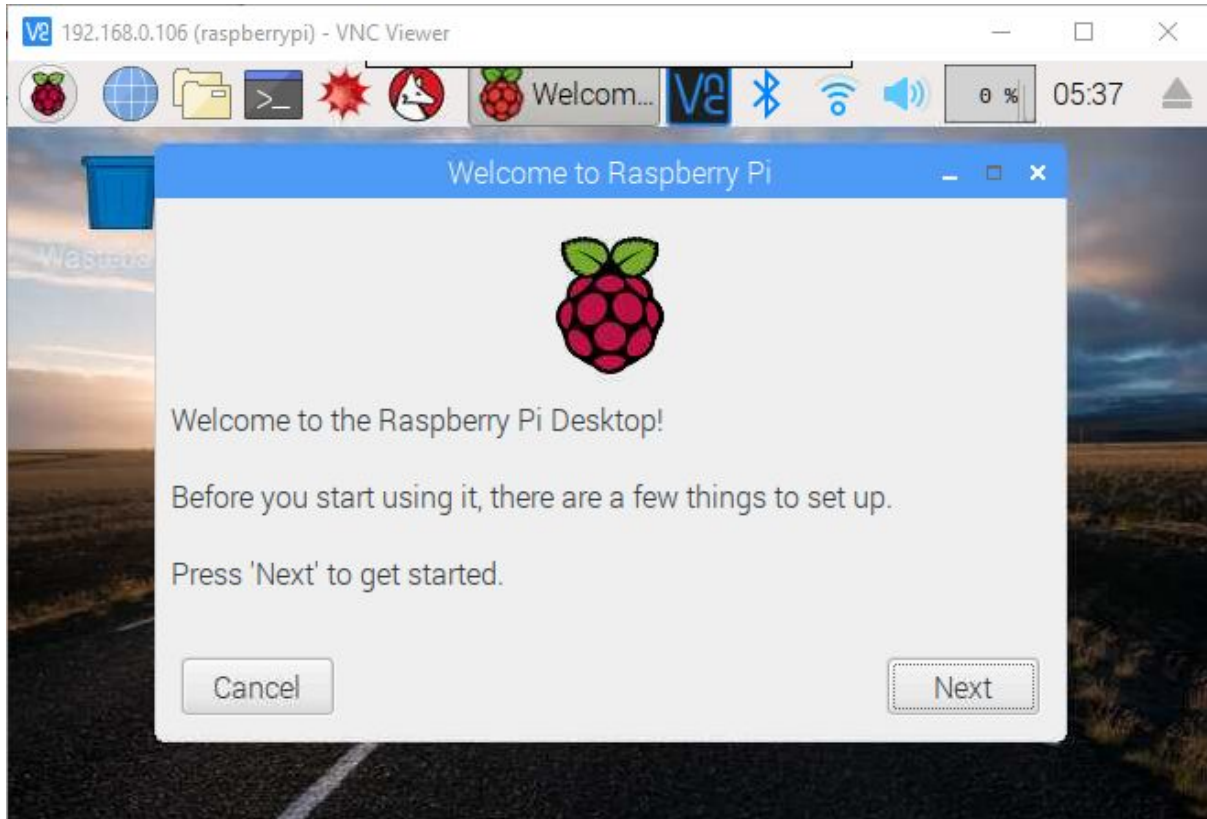

## 7. HIGHLIGHTED FEATURES

Maker pHAT incorporates 4 interesting features which make it interesting and more suitable for beginner. Below are the detailed descriptions for each feature.

### 7.1 LEDs at Selected GPIO Pins

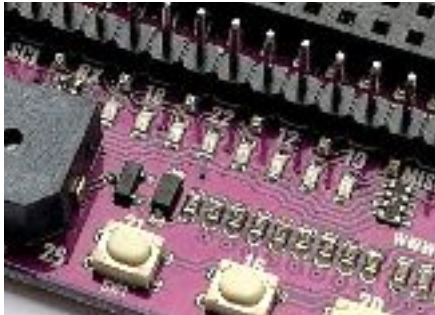

8 LEDs is connected to GPIO 17, 18, 27, 22, 25, 12, 13 and 19. Those LED can be controlled as an output or can be act as an input (signal monitoring). In other words, GPIO that connected to the LED, can be configured as output, input and input pull up.

### 7.2 Programmable Push Buttons

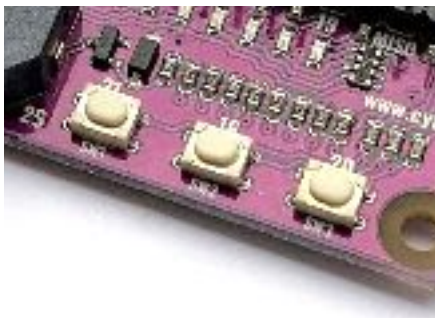

3 units of programmable push button are included in the Maker pHAT. To utilize it, user need to configure push button GPIO as input pullup.

- SW1 is connected to GPIO 21
- SW2 is connected to GPIO 16
- SW3 is connected to GPIO 20

### 7.3 On-board Active Buzzer

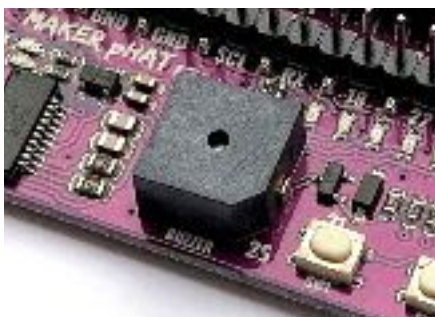

Maker pHAT also comes with on-board active buzzer. It is standard output digital device connected to GPIO 26. To activate it, set GPIO to high, and to mute it, just set GPIO to low.

### 7.4 USB to Serial for Serial Remote



Serial remote is a helpful tool to get started with Raspberry Pi. Luckily, Maker pHAT comes with USB to Serial module for this purpose. It is connected to Raspberry Pi's UART pin (RX and TX). Please refer to [Getting Started section](#) for more detail.

## 8. PYTHON DEMO CODE

User can try this python demo code to control the LEDs and buzzer using push button on Maker pHAT. Click on **Menu - Programming - Python 3 (IDLE)**. Then click **File - New File**. Write (or copy and paste) the following python code ([gist](#)).

```
MakerpHATDemo.py - /home/pi/Documents/MakerpHATDemo.py (3.5.3)
File Edit Format Run Options Window Help

from gpiozero import LED, Button, Buzzer
from time import sleep
import os

LED1 = LED(17)
LED2 = LED(18)
LED3 = LED(27)
LED4 = LED(22)
LED5 = LED(25)
LED6 = LED(12)
LED7 = LED(13)
LED8 = LED(19)

SW1 = Button(21)
SW2 = Button(16)
SW3 = Button(20)

BUZZER = Buzzer(26)

NONE = 0
DECREASE = 1
INCREASE = 2
ALL_OFF = 9
ALL_ON = 10

def beep(times, sec):
    for x in range(times):
        BUZZER.on()
        sleep(sec)
        BUZZER.off()
        sleep(sec)

def led(ledNumber):
    if ledNumber == 1:
        LED1.on()
    else:
        LED1.off()

    if ledNumber == 2:
        LED2.on()
    else:
        LED2.off()

    if ledNumber == 3:
        LED3.on()
    else:
        LED3.off()
```



```
if ledNumber == 4:
    LED4.on()
else:
    LED4.off()

if ledNumber == 5:
    LED5.on()
else:
    LED5.off()

if ledNumber == 6:
    LED6.on()
else:
    LED6.off()

if ledNumber == 7:
    LED7.on()
else:
    LED7.off()

if ledNumber == 8:
    LED8.on()
else:
    LED8.off()

if ledNumber == ALL_OFF:
    LED1.off()
    LED2.off()
    LED3.off()
    LED4.off()
    LED5.off()
    LED6.off()
    LED7.off()
    LED8.off()
elif ledNumber == ALL_ON:
    LED1.on()
    LED2.on()
    LED3.on()
    LED4.on()
    LED5.on()
    LED6.on()
    LED7.on()
    LED8.on()

mode = NONE
ledPosition = 0

led(ALL_ON)
beep(1, 0.1)
led(ALL_OFF)

try:
    while True:
        if SW1.is_pressed and mode != DECREASE:
            beep(2, 0.07)
            mode = DECREASE
```

```
elif SW2.is_pressed and SW3.is_pressed:
    sleep(0.5)
    for loop in range(times):
        BUZZER.on()
        led(ALL_ON)
        sleep(0.2)
        BUZZER.off()
        led(ALL_OFF)
        sleep(0.2)
    sleep(0.5)
    os.system("sudo shutdown -h now")

elif SW2.is_pressed and mode != INCREASE:
    beep(2, 0.07)
    mode = INCREASE

elif SW3.is_pressed and mode != NONE:
    beep(1, 0.07)
    mode = NONE

if mode == INCREASE:
    if ledPosition < 8:
        ledPosition = ledPosition + 1
    else:
        ledPosition = 0

elif mode == DECREASE:
    if ledPosition > 0:
        ledPosition = ledPosition - 1
    else:
        ledPosition = 8

led(ledPosition)

sleep(0.05)

except KeyboardInterrupt:
    led(ALL_OFF)
```

To run it, click **Run - Run Module** (or can press F5). You need to save your python code first. You can save your code in Documents folder. Write **MakerpHATDemo.py** and save. Python Shell window will popup. Wait until you hear a beep from Maker pHAT.

```
*Python 3.5.3 Shell*
File Edit Shell Debug Options Window Help
Python 3.5.3 (default, Sep 27 2018, 17:25:39)
[GCC 6.3.0 20170516] on linux
Type "copyright", "credits" or "license()" for more information.
>>>
===== RESTART: /home/pi/Documents/MakerpHATDemo.py =====
|
```

Now you can control the LED by pressing the push buttons.

- SW1: Buzzer will produce double beep. LED will running from right (GPIO 19) to left (GPIO17).
- SW2: Buzzer will produce double beep. LED will running from left (GPIO 17) to right (GPIO19).
- SW3: Buzzer will produce single beep. LED stop running.
- Hold SW2 and SW3: Raspberry Pi shutdown.

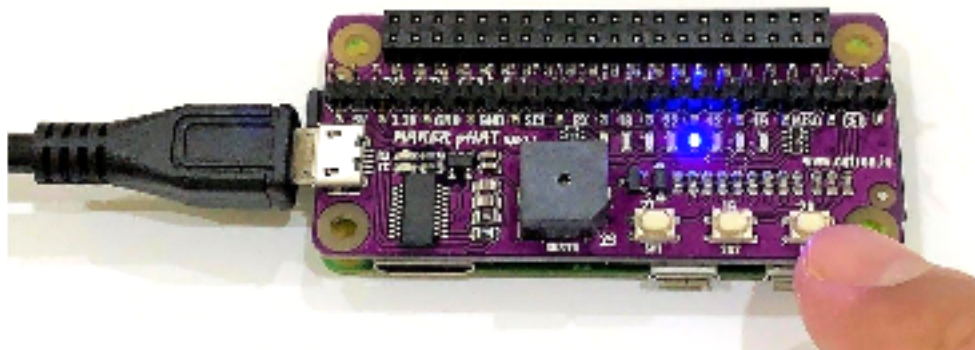

# 9. SCHEMATIC

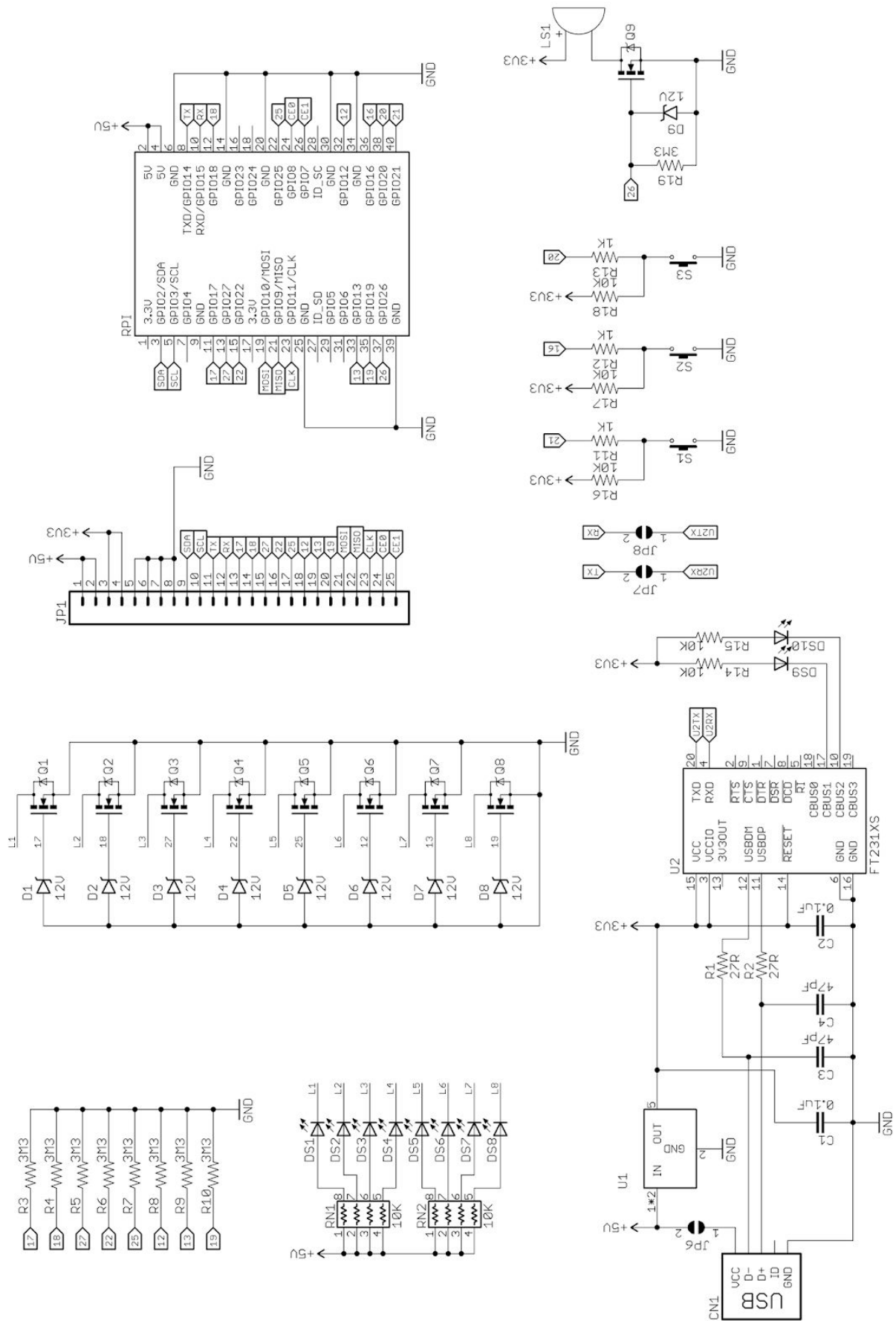

## 10. GALLERY

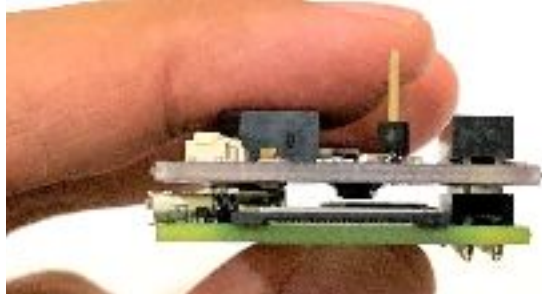
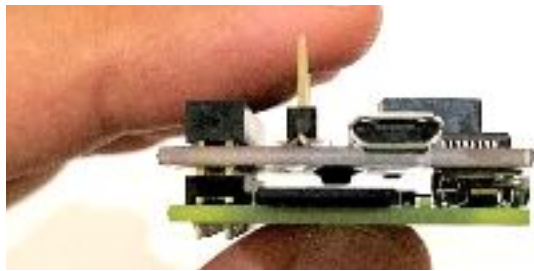





## 11. WARRANTY

- Product warranty is valid for 1 year.
- Warranty only applies to manufacturing defect.
- Damaged caused by misuse is not covered under warranty.
- Warranty does not cover freight cost for both ways.

*Prepared by:*

**Cytron Technologies Sdn Bhd**

[www.cytron.io](http://www.cytron.io)

No. 1, Lorong Industri Impian 1,  
Taman Industri Impian,  
14000 Bukit Mertajam,  
Penang, Malaysia.

*Tel:* +604 - 548 0668

*Fax:* +604 - 548 0669

*Email:*

[support@cytron.io](mailto:support@cytron.io)

[sales@cytron.io](mailto:sales@cytron.io)